

**Relay**

ELECTROMAGNETIC RELAY SERIES				
3SJ4M-2,-S,-N-F,-O	3SJ4M-3,-S,-N-F,-O	3SJ4M-4,-S,-N-F,-O	3SJ5-2P-1,-S,-N	3SJ5-3P-1,-S,-N
				
27.5×21.5×35	27.5×21.5×35	27.5×21.5×35	34.5×34.5×52	34.5×34.5×52
2Z	3Z	4Z	2Z	3Z
5A 250V AC	5A 250V AC	3A 250V AC	10A 250V AC,DC28V	
6~220V			6~220V	
6~380V			6~380V	
DC:≤0.9W AC:≥1.2VA			DC:≤0.9W AC:≥1.2VA	
DC:≥75% AC:≥80%			DC:≥75% AC:≥80%	
DC:≥10% AC:≥30%			DC:≥10% AC:≥30%	
≤50mΩ			≤50mΩ	
≤100MΩ			≤100MΩ	
10 <sup>5</sup> times			10 <sup>5</sup> times	
10 <sup>7</sup> times			10 <sup>7</sup> times	
1000v rms			1000v rms	
1500v rms			1500v rms	
P.C.B & Socket 			Socket 	
-40℃~+55℃			-40℃~+55℃	
About 35g	About 35g	About 35g	About 85g	About 85g
			 Model Q  Model T	 Model Q  Model T
L10KH2 HH52P 4104	L10KH2 HH53P 4104	L10KH2 HH54P 4104	H,K FRM5	H,K FRM5
PYF08A PYF08A-E PY08	PYF11A PYF11A-E PY11	PYF14A PYF14A-E PY14	PF083A PF083A-E US-08	PF113A PF113A-E US-11
With lamp:-N,FLANGE:-F, With button:-S,PCB:-O			With lamp:-N, With button:-S	

**Relay Sockets**

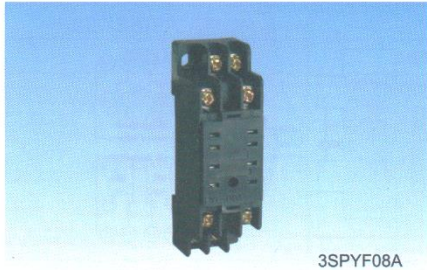

3SPYF08A

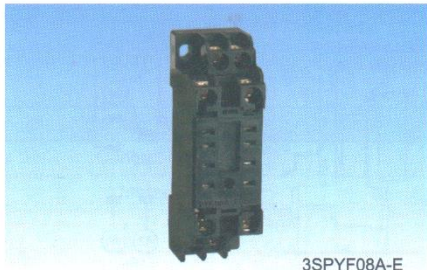
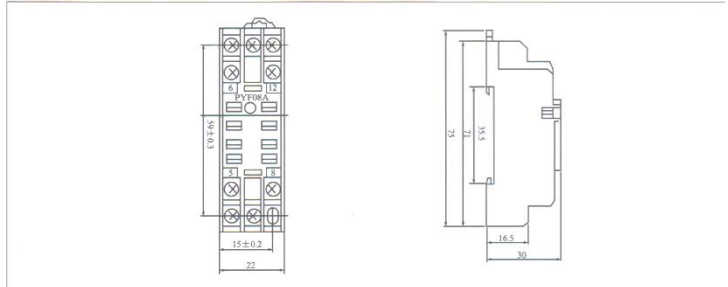

3SPYF08A-E

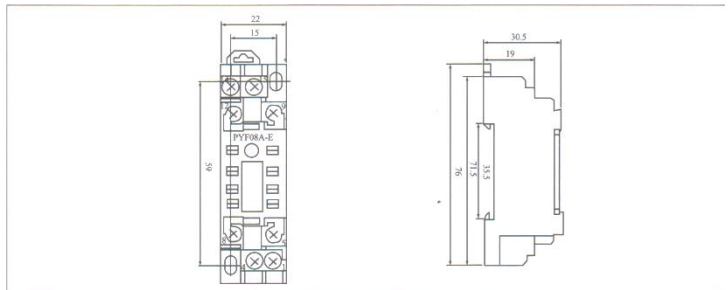

3SPYF11A

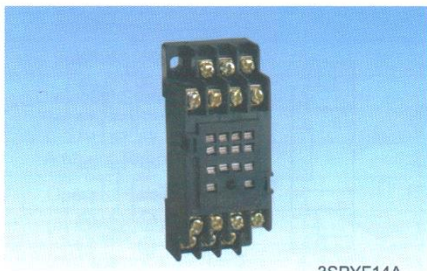
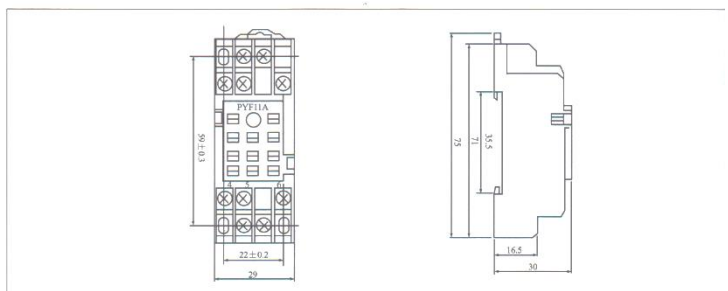

3SPYF14A

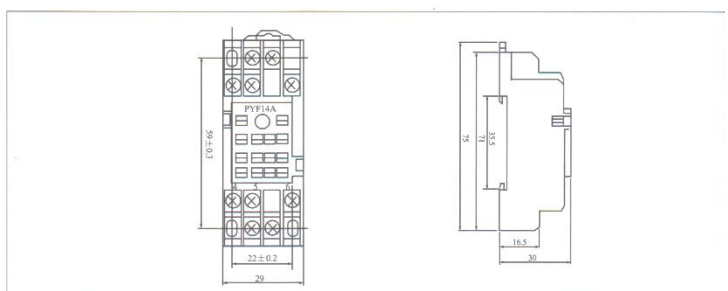

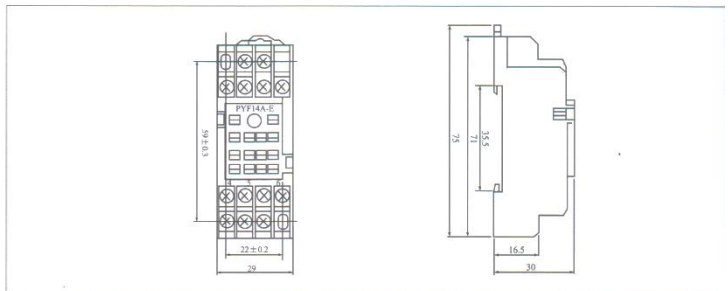

3SPYF14A-E





**Relay Sockets**

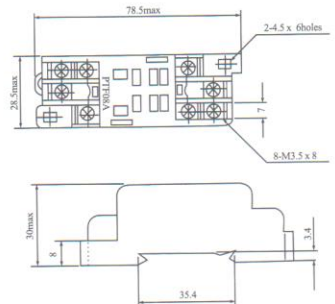



3SPTF08A

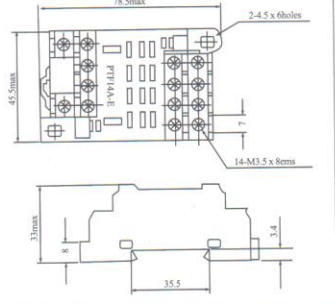

3SPTF14A-E

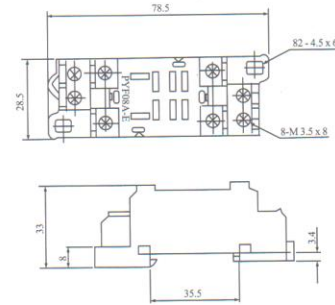

3SPTF08A-E

3SPF083A

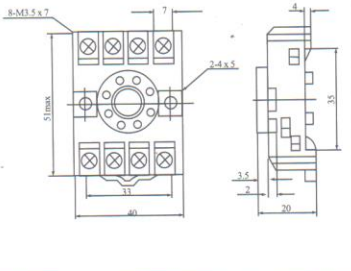

3SPTF11A

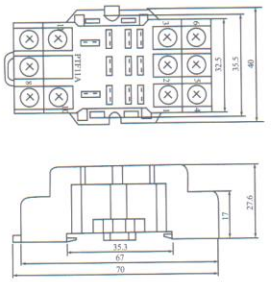
3SPF083A-E

3SPTF14A

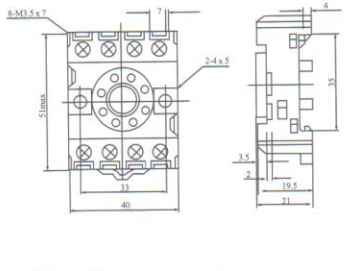
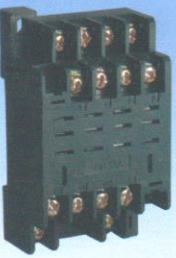
3SPF113A

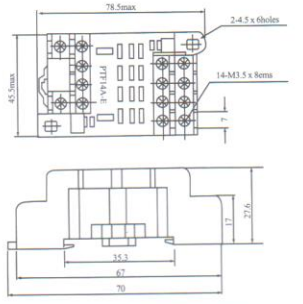